



# MANAGING YOUR UTILITIES DURING A DISASTER



*When disaster strikes, it often affects one or more of the utility systems in our homes. It is important to know where the main controls are located as well as how – and whether – to turn them off.*

**ELECTRICITY** - A disaster can disrupt your electrical service or cause wires and electrical fixtures to separate, creating a shock and fire hazard.

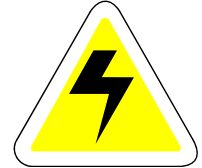

## **Before a disaster occurs:**

- Locate your main electrical panel or fuse box. It is most commonly located on an interior wall near your electric meter.
- If your residence has a fuse box, maintain a supply of spare fuses of the correct amperage.
- Always keep a working flashlight available, with extra batteries of the correct size and type.

**When you lose power,** check the fuses and/or circuit breakers to be sure the trouble is not in your household electric system.

- **Turn off** all electrical equipment (e.g., water heater, electric furnace, heaters, TV/computer, appliances) to prevent system overload when the power is restored.
- **Turn on** a porch light and one inside light so you and utility crews will know when service is restored.
- If you have to step in water to get to the fuse box or circuit breaker, call an electrician first for advice.
- If a generator is used as backup power supply, remember to follow the manufacturer's instructions. Connect lights and appliances directly to the generator and not the electrical system. An alternative method is to hire a licensed electrician to wire your generator into your electrical system.

**If you see sparks** or broken/frayed wires, or if you smell hot insulation, shut off your electricity immediately.

- For a circuit breaker panel - Shut off the electricity by turning all circuit breaker switches to the "off" position – individual circuits first, then main circuit.
- For a fuse box, pull out the two main (cartridge) fuses.

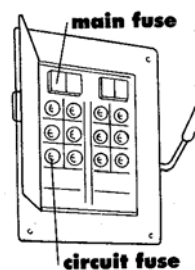

**Fuse Boxes**

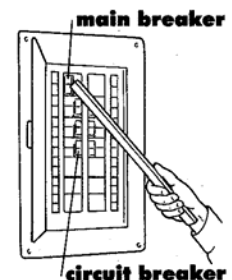

**Breaker Boxes**

**NATURAL GAS** - Any odor of natural gas inside your home might indicate a leak. If you smell natural gas or hear blowing or a hissing noise, open a window and quickly leave the building. Turn off your gas at the meter as soon as possible:

- Locate the shut-off valve.
- Using a cutoff tool or adjustable wrench, turn the rectangular knob one quarter-turn clockwise to the horizontal position.
- Call 9-1-1 from a neighbor's home.

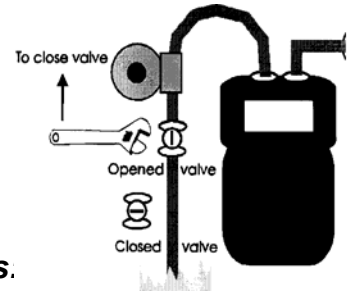

Once you turn off your gas at the meter, service can be restored only by a professional. **If you don't suspect a gas leak, don't turn off your gas.** You may unnecessarily deprive yourself of an important utility.

**If you suspect a gas leak:**

**DON'T** use your telephone. This includes cellular phones and all types of portable communication and electronic devices that have battery. These can spark and could create an explosion

**DON'T** use matches, lighters, or open flame appliances, and **DON'T** operate electrical switches.

**WATER** - Earthquakes and freezing weather can rupture water pipes, causing flooding if not turned off quickly. Find the location of your home's shut off valve.

- There is a shut off valve at the water meter, but there may also be one closer to your house.
- Some common places to look for your master shut off valve are:
  - In the crawl space or basement where the water line enters the house.
  - In the garage where the water line enters the wall or ceiling, near the water heater, or by the clothes washer hookup.
  - Outside, near the foundations of your home, possibly protected by a concrete or clay pipe ring.

If you don't find a hand-operated master shut off valve, have one installed on the house side of the meter; it will make it easier to shut off your water in an emergency.

Water Meter

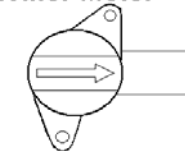

Open / On

Home Side

Water Meter

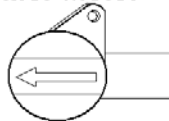

Closed / Off

Home Side

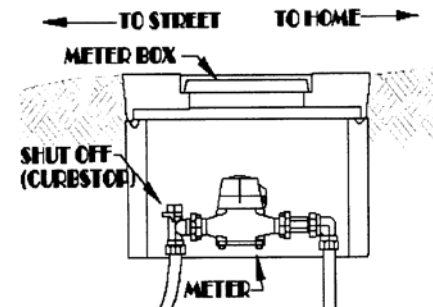

Your sewer system could be damaged in a disaster such as an earthquake, landslide, or flood. With this possibility in mind, be prepared to set up a back-up method for the collection and sanitation of human waste.